









ABSINTHE

De Meutter bv
Industriepark 14A Zone B
2220 Heist-op-den-Berg
BELGIUM

INPUT : 220-240V ~ 50/60Hz CLASS II 	    
LAMP-HOUSE : GUITO-35W (Max.)	
MATERIAL : ALUMINIUM	

INSTALLATION INSTRUCTION

1. Before installing, make sure the power supply is switched off.
2. Follow the steps as the figure for installation or replacement of bulb

Fig: A. holing.

- B. connect the wires to the terminal block.
 - C. fix the bulb.
 - D. fix the bulb to the body.
 - E. insert the body to the ceiling.
3. After finishing every step, have the fixture fixed, and then connect the power supply.

CLEANING INSTRUCTION

1. Before cleaning, ensure that the power supply is switched off.
2. Use only a soft cloth to clean the lamp, dampened with mild cleanser if needed for resistant dirt.
3. Warning: do not use alcohol or other solvents!

CAUTION:

While the lamp is working, the surface of it is hot!
Please do not touch the fixture within an hour after the power supply has been switched off.

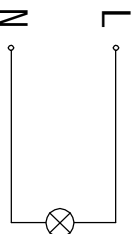

HOLE SIZE: $\phi 65\text{mm}$

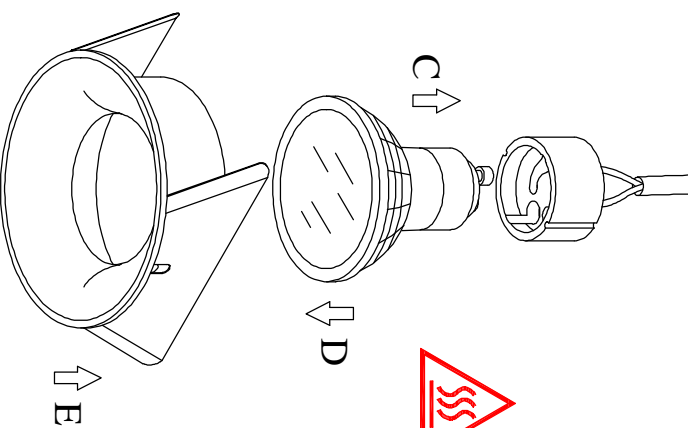
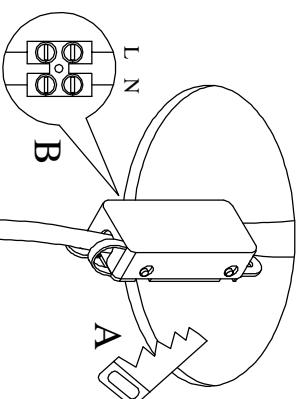

 CAUTION: WHILE THE LAMP IS WORKING, THE SURFACE OF IT IS VERY HOT, PLEASE DO NOT TOUCH!

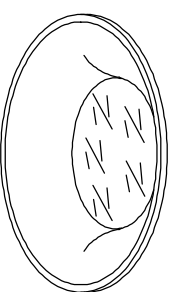

- 12073-01
- 12073-02
- 12073-03
- 12073-10

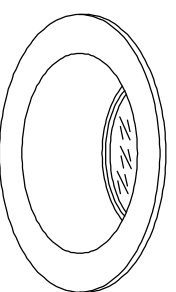

- 12074-01
- 12074-02
- 12074-03
- 12074-10